

# FS980

## CERNIERA CHIUDIPIORTA A PAVIMENTO

### FLOOR SPRINGS / HYDRAULIC HINGE

**PER PORTA IN LEGNO E ALLUMINIO**

**FOR WOODEN AND ALUMINIUM DOOR**



**FORZA FISSA (EN 3)**  
**POWER SIZE (EN 3)**

**PRODOTTO TESTATO SECONDO LA NORMATIVA EN 1634**

**EN 1634 TESTED PRODUCT**

DC

FS

## APPLICAZIONI E MONTAGGIO APPLICATIONS AND MOUNTING

Regolazioni		Adjustments	
Laterale	mm $\pm$ 3	Side	mm $\pm$ 3
Frontale	mm $\pm$ 3	Front	mm $\pm$ 3
Allineamento ante	$\pm$ 4°	Door alignment	$\pm$ 4°

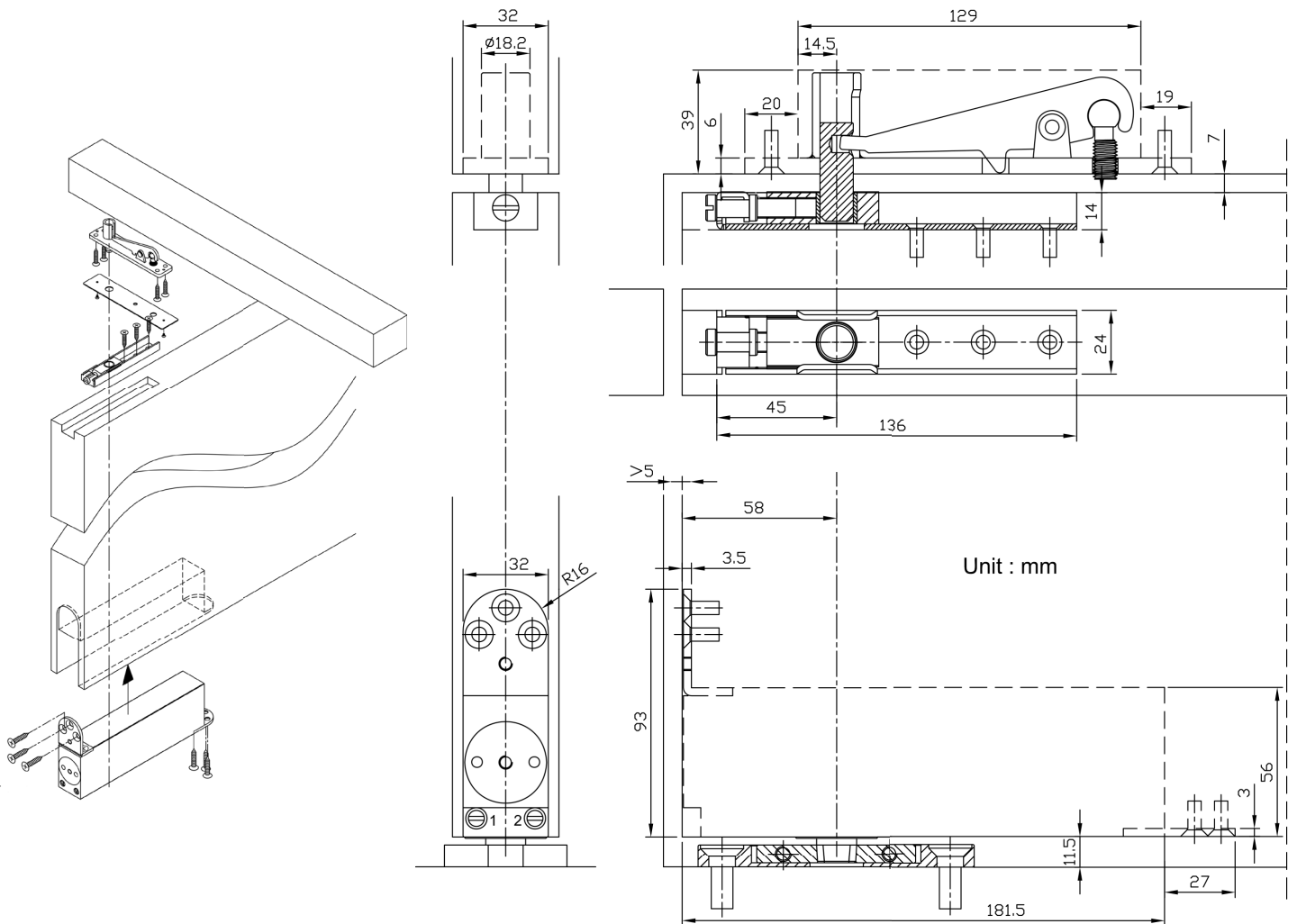
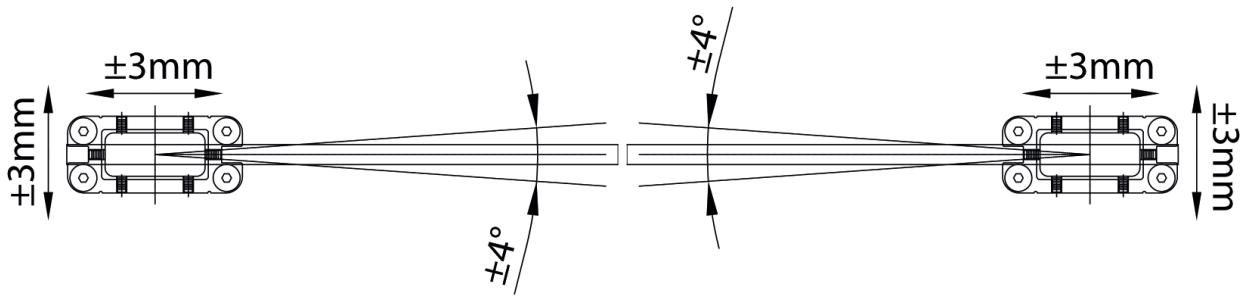

Perno regolabile per cerniera  
Adjustable pivot for hinge  
DAPF980R

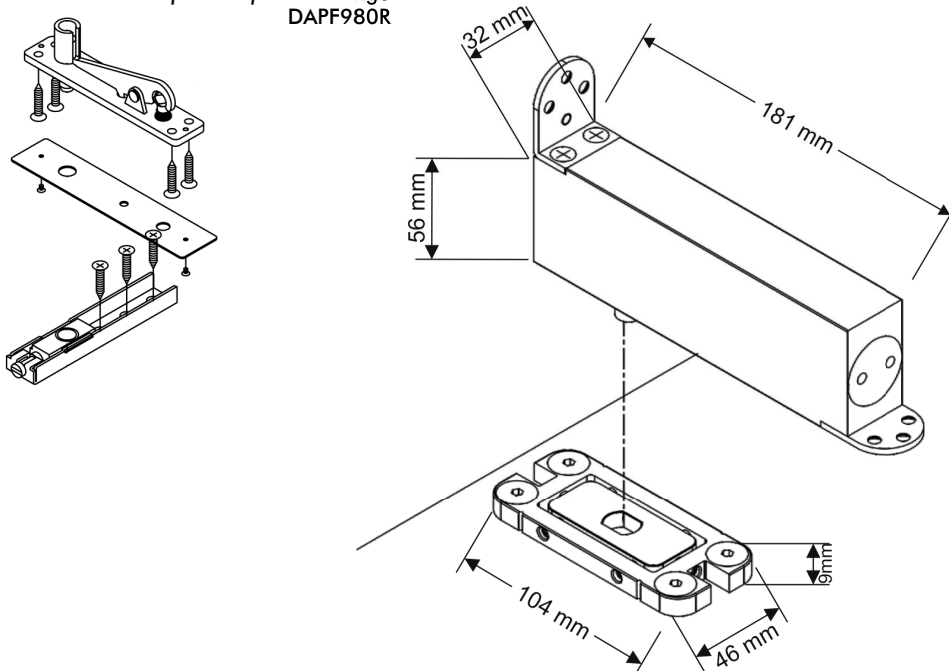

### CARATTERISTICHE TECNICHE FS980

### TECHNICAL FEATURES FS980

Forza fissa	EN 3	Power size	EN 3
Massima larghezza porta	850 - 950 mm	Maximum door width	850 - 950 mm
Peso porta	Max 100 Kg	Door weight	Max 100 Kg
Spessore porta	≥40 mm	Door thickness	≥40 mm
Temperatura d'esercizio	-20°C / +50°C	Operating temperature	-20°C / +50°C
Esecuzione per porta battente	DIN destro - DIN sinistro	Non - Handed	DIN right - DIN left
Esecuzione per porta a ventola	Si	Double action door	Yes
Velocità di chiusura regolabile	150° - 10°	Adjustable closing speed	150° - 10°
Velocità colpo finale regolabile	10° - 0°	Adjustable braking speed	10° - 0°
Angolo di apertura	Max 150°	Angle of opening	Max 150°
Angolo di fermo porta	90° Versione senza fermo su richiesta	Hold open	90° Non hold open version on request
Finiture standard cover	Acciaio satinato Acciaio lucido	Cover standard finishes	Satin steel Polish steel
Dimensioni	Lunghezza 181 mm Altezza 56 mm Spessore 32 mm	Dimensions	Length 181 mm Height 56 mm Thick 32 mm
Confezione	Scatola da 1 pz	Packaging	Box in 1's
Peso (inclusa confezione)	Kg 2,30	Weight (box included)	Kg 2,30

## VELOCITÀ DI CHIUSURA CLOSING SPEED

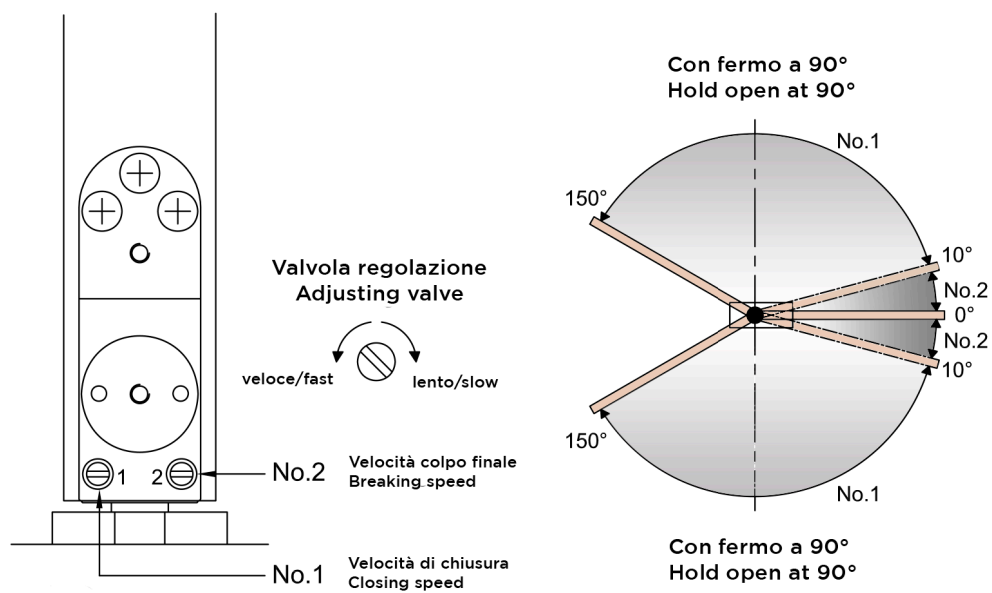

---

## COMPONENTI FS980 COMPONENTS FS980

