



## Reggimensola registrabili tipo MN113 Adjustable shelf support type MN113

**CATAS**<sup>®</sup>  
Test Report 157327



DIAGRAMMA DI CARICO  
LOADING CAPACITY DIAGRAM

CARATTERISTICHE FONDAMENTALI:  
DOPPIA REGOLAZIONE  
"A" ORIZZONTALE E VERTICALE.  
"B" INCLINAZIONE.  
"C" POSSIBILITA' DI AVVITARE UN GRANO NELLA GOLA PER EVITARE LO SFILAMENTO DELLA MENSOLA. SI CONSIGLIA DI FARE LE REGOLAZIONI APPoggiANDO LA MENSOLA SUI REGGIMENSOLA, E UNA VOLTA ESEGUITE LE REGOLAZIONI INFILARE LA MENSOLA NELLE OPPORTUNE SEDI.

GENERAL ADVANTAGES:  
DOUBLE ADJUSTMENTS  
"A" HORIZONTAL AND VERTICAL  
"B" INCLINATION  
"C" POSSIBILITY TO INSERT A GRAIN FOR ANTI-DROP SYSTEM. WE SUGGEST TO ADJUST BY LOCATING THE SHELF UPON THE SUPPORTS, AND INSERT IT AFTER THE ADJUSTMENTS.

acciaio - zama  
steel - die-cast

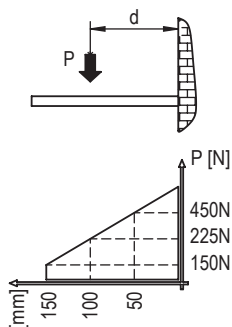
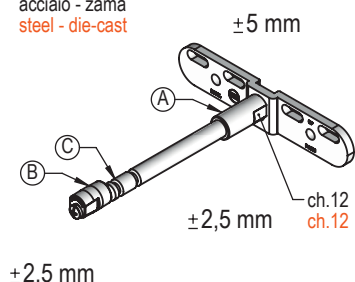

fori Ø6.5 per tasselli chimici  
6.5 mm hole for chemical fishers

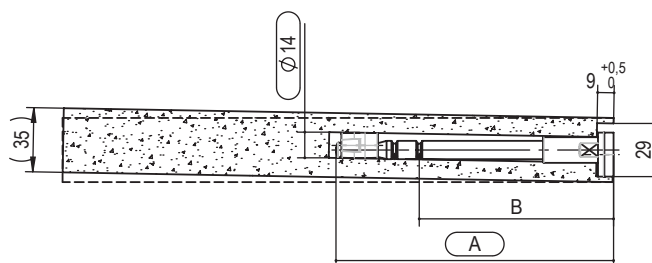
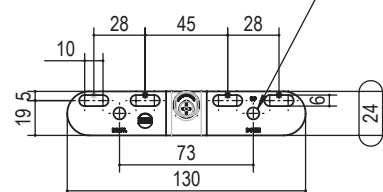

tipo type	misura measure	A	B	finitura finishing	box	kg / box
A.MN113.	120.	120	75	02 zincato bianco white zinc	100	16,8
	150.	150	105			18,2
	175.	175	130			19,8

es./e.g.: A.MN113.150.02

## Reggimensola registrabili tipo MN114 Adjustable shelf support type MN114

**CATAS**<sup>®</sup>  
Test Report 155666



DIAGRAMMA DI CARICO  
LOADING CAPACITY DIAGRAM



DISPONIBILI TASSELLI PER  
CARTONGEZZO  
AVAILABLE FOR DRYWALL  
ANCHORS

acciaio - zama  
steel - die-cast

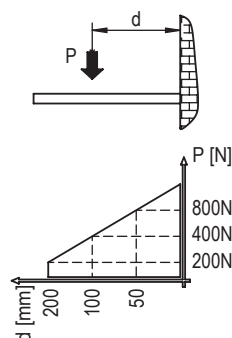
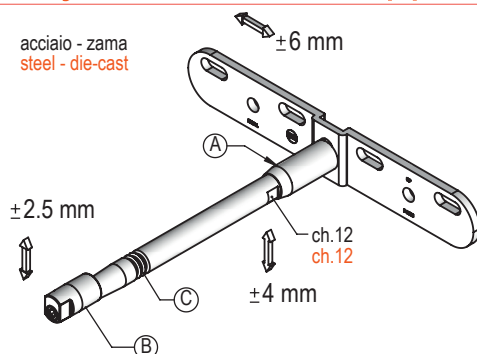

fori Ø8.5 per tasselli chimici  
8.5 mm hole for chemical fishers

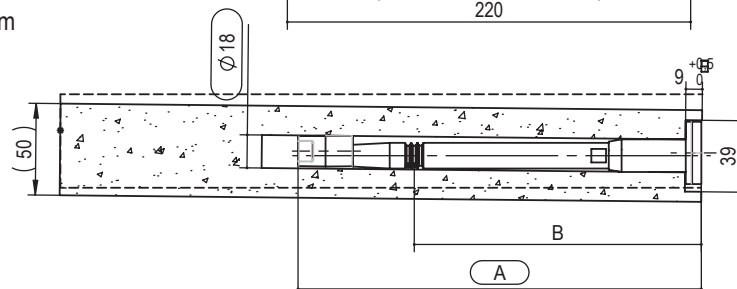
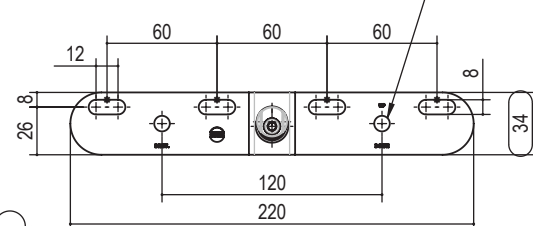

tipo type	misura measure	A	B	finitura finishing	box	kg / box
A.MN114.	220.	220	145	02 zincato bianco white zinc	25	26,2
	350.	350	175			32

es./e.g.: A.MN114.350.02